

Nobel approach of power feeding for cellular mobile telephony base station site: Hybrid energy system

Pragya Nema

Electrical Engineering Department, Lakshmi Narain College of Technology, Indore, Madhya Pradesh

Email address:

pra3sam@yahoo.co.in

To cite this article:

Pragya Nema. Nobel Approach of Power Feeding for Cellular Mobile Telephony Base Station Site: Hybrid Energy System. *International Journal of Energy and Power Engineering*. Special Issue: Distributed Energy Generation and Smart Grid. Vol. 3, No. 6-2, 2014, pp. 7-14. doi: 10.11648/j.ijjepe.s.2014030602.12

Abstract: The problem of providing energy to remotely located systems is a serious concern for the telecom industry, specially powering the mobile telephony towers in rural areas, which lacks quality grid power supply. The feasible solution looks to be in the form of omnipresent and technically viable alternative renewable energy based stand alone hybrid system. In order to meet sustained load demands during varying natural conditions, different energy sources and converters need to be integrated with each other. This paper presents and explores the possibility of putting hybrid energy system for powering cellular mobile base station sites. Looking at Indian weather conditions, the most feasible configuration is the stand alone PV/Wind Hybrid Energy System with diesel generator as a backup for cellular mobile telephony base station site. This system will be more cost effective and environmental friendly over the conventional diesel generator based systems in near future.

Keywords: Hybrid Energy Systems, Mobile Telephony Base Station, Wind Turbine, PV-Solar, Optimization

1. Introduction

Obtaining reliable and cost effective power solutions for the worldwide expansion of telecommunications into rural and remote areas presents a very challenging problem. Grids are either not available or their extensions can be extremely costly in remote area. Although initial costs are low, powering these sites with generators require significant maintenance, high fuel consumption and delivery costs due to hike in fuel prices. The present work explores the possibility of putting HES for powering mobile telephone towers in India. A sustainable alternative [2] to power remote base station sites is to use renewable energy sources. Recent research and development of Renewable energy sources have shown excellent potential as a form of contribution to conventional power generation systems. In order to meet sustained load demands of mobile base station during varying natural conditions, different energy sources and converters need to be integrated with each other for extended usage of alternative energy [1].

For Indian remote location, one of the best alternative solutions of renewable energy sources [3] shall be wind-solar Hybrid Energy System [7] for mobile base station. This will ensure reliable, uninterrupted, quality power with least

maintenance and manual interference for operation. The use of the stand-alone solar-wind with diesel backup system [6] for the power supply of remote areas gives an economically attractive alternative for mobile telecom sector over the use of conventional diesel generators in near future. This paper gives the design idea of wind, solar-photovoltaic hybrid energy system.

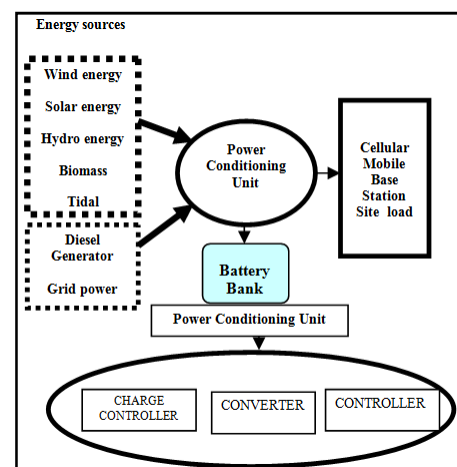

Fig. 1. Block Diagram of Hybrid Energy System for Cellular Mobile Telephony Base Station Site.

Based on the energy consumption of mobile base station and the availability of renewable energy sources, it was decided to implement an innovative stand alone, self reliant Hybrid Energy System[4] combining small wind turbine-generator, solar photo-voltaic panels, battery storage, advance power electronic equipment and existing diesel generator as a backup. The system architecture employed in the hybrid system is AC-coupled where the renewable energy sources and the conventional diesel generators all feed into the AC side of the network as shown in Fig.1.

The availability of renewable energy resources [5] at mobile base station sites is an important factor to develop the hybrid system. Many parts of the India wind and solar energy are abundantly available. These energy sources are intermittent and naturally available; due to these factors our first choice to power the mobile base station will be renewable energy sources such as wind and solar [8].

2. Hybrid System Components

2.1. PV Energy Conversion Systems

The PV energy conversion systems are the combination of solar-PV module, power electronic interface and DC-DC converters for maximum power extraction from Sun. The photovoltaic panels are the principal component to convert solar energy into electrical energy. The solar cell produced direct current, so when they are used for A.C. load, they must be linked by an inverter to convert the DC-AC. Solar Cell could be electrically connected together to form a photovoltaic module, and several module could be put together to form arrays. Fig.2(a) shows the basic structure of a typical solar energy conversion system.

In this present work, the solar photovoltaic module is manufactured by TATA-BP solar, India are used .The detail specification of solar PV module is given here as under.

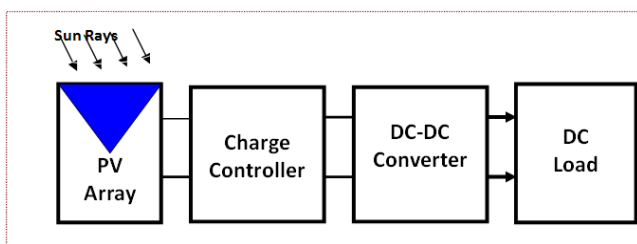

Fig. 2(a). Solar photovoltaic energy conversion system

Two types of Solar PV modules are used for designing the hybrid energy system. Here the detail specifications are taken for 38 W and 75 W PV module, that is manufactured by-M/s- TATA BP solar INDIA [9]

- 1) 38 W, 17.7Volt 2.2Amp at 25degree Celsius and 1000W/m²
- 2) 75 W, 17.7Volt, 4.44 Amp at 25degree Celsius and 1000W/m²

Multi-crystalline type phovoltaic module is shown in Fig.2 (b), each module having 36 cells. These types of solar

module are efficient and give more power then mono crystalline type photovoltaic module.

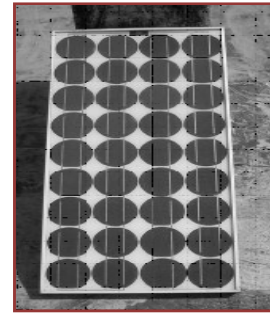

Fig. 2(b). Solar Module

The ideal equivalent circuit of a solar cell consists of a current source in parallel with a diode. The output terminals of the circuit are connected to the load. Ideally the voltage current equation of the solar cell [1] is given by:

$$I_{pv} = I_{ph} - I_o \left(e^{\frac{qV_{pv}}{kT}} - 1 \right) \tag{1}$$

Where:

- I_{ph} = Photo current (A);
- I₀ = Diode reverse saturation current (A);
- q = Electron charge = 1.6X10⁻¹⁹ (C);
- k = Boltzman constant = 1.38X10⁻²³ (J/K);
- T = Cell temperature (K)

The power output of a solar cell is given by

$$P_{pV} = V_{pV} * I_{pV} \tag{2}$$

Where:

- I_{pV} = Output current of solar cell (A).;
- V_{pV} = Solar cell operating voltage (V).
- P_{pV} =Output power of solar cell (W).

The power-voltage (P-V) characteristic of a photovoltaic module operating at a standard irradiance of 1000 W/m² and temperature of 25degree Celsius [6] shown in Fig.3.

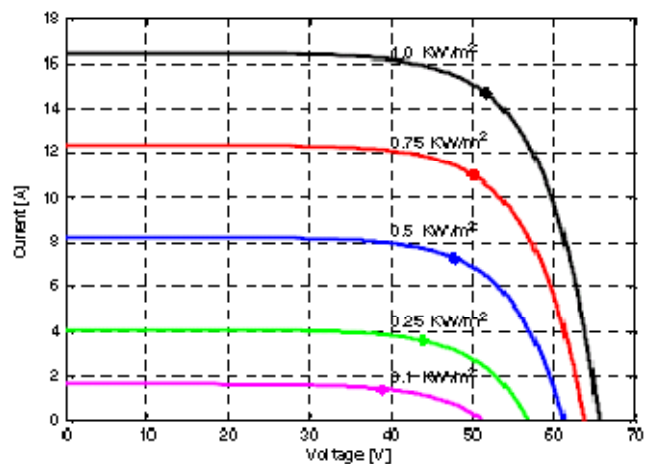

Fig. 3(i). I-V Characteristics of PV Module.

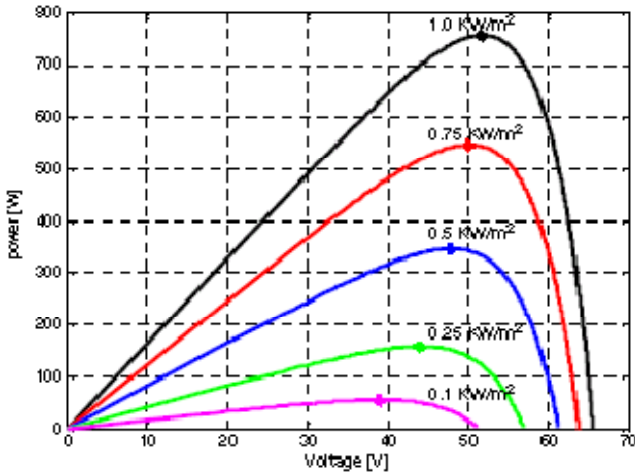

Fig. 3(ii). P-V Characteristics of PV Module

2.2. Wind Energy Conversion System (WECS)

The wind energy conversion system consists of a horizontal axis wind turbine coupled to a permanent magnet synchronous generator. An AC-DC power electronics interface with diode bridge rectifier and DC-DC converter are used to track and extract maximum power available from wind energy conversion system for a given wind velocity and deliver this power to base transceiver station load. The concept block diagram of wind energy conversion system is shown in Fig.4

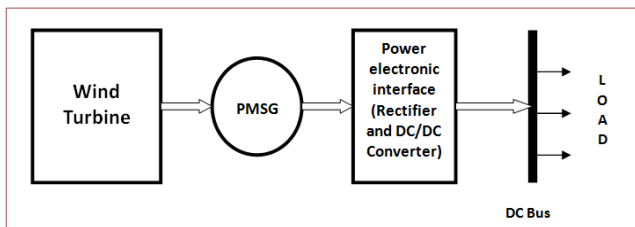

Fig. 4. Wind energy conversion system

The wind Turbine is characterized by non- dimensional performance as a function of tip speed ratio. The output of mechanical power captured from wind by a wind turbine [7] can be formulated as:

$$P_t = -(C_p \lambda \rho A V^3) / 2 \tag{3}$$

And Torque developed by wind turbine can be expressed as

$$T_t = P_t / \omega_m \tag{4}$$

Where:

P_t =Output power;

T_t =torque developed by wind turbine,

C_p =Power co-efficient,

λ =Tip speed ratio

ρ =Air density in Kg/m³;

A=Frontal area of wind turbine;

V=wind speed

Where

$$\lambda = \omega R / v \tag{5}$$

In equation (5), R and v are the turbine rotor speed in “rad/s”, radius of the turbine blade in “m”, and wind speed in “m/s” respectively. Wind power curves are shown in Fig.5.

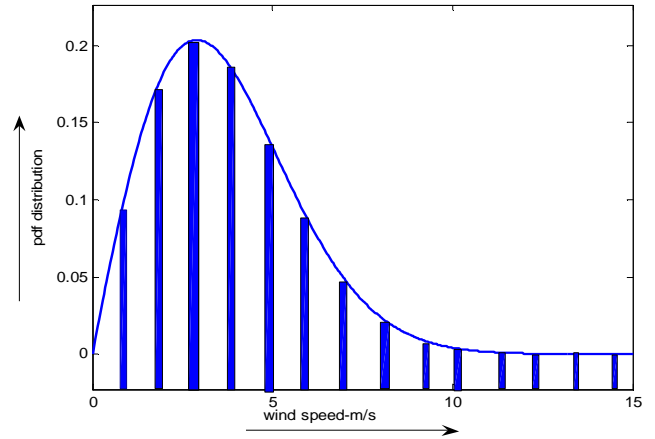

Fig. 5(i). PDF Distribution of Wind Speed

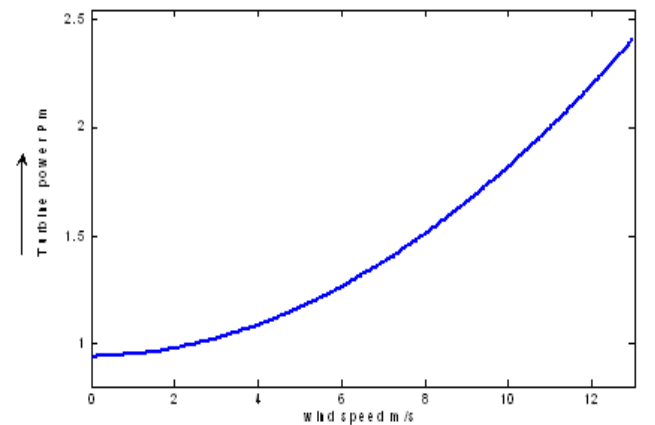

Fig. 5(ii). Wind Turbine Power Curve

2.3. Diesel Generator

If the load required are not met by either renewable energy system or by batteries (due to state of charge), then the load requirements are met by operating diesel generator in HRES. The choice of diesel generator depends on type and nature of the load. To determine rated capacity of the engine generator to be installed, following two cases should be considered:

- 1 If the diesel generator is directly connected to the load, then the rated capacity of the generator must be at-least equal to the maximum load and
- 2 If the diesel generator is used as a battery charger, then the current produced by the generator should not be greater than $C_{Ah}/5$ A, where C_{Ah} is the ampere hour capacity of the battery.
- 3 Overall efficiency of the diesel generator is given by

$$\eta_{Overall} = \eta_{break\ thermal} \times \eta_{break\ generator}$$

Where $\eta_{break\ thermal}$ is brake thermal efficiency of diesel engine. Normally diesel generators are modelled in the

control of the hybrid power system in order to achieve required autonomy. It is observed that if the generator is operated at 70-90% of full load then it is economical. In the absence of peak demand, diesel generators are normally used for meeting load requirements and for battery charging. Diesel engines drive synchronous generator, which are equipped with governors and automatic voltage regulator.

2.4. Inverter

The inverter is built with the IGBT/Diode block which is the basic building block of all Voltage Source Converters. The IGBT/Diode block is a simplified model of an IGBT or Diode pair where the forward voltages of the forced-commutated device and diode are ignored. Voltage source inverter is controlled in open loop with the Discrete PWM Generator block available in the Extras/Discrete Control Blocks library. Start the simulation, after a transient period of approximately 50 ms, the system reaches a steady state. Observe voltage waveforms at DC bus, inverter output and load on response.

The above mentioned two fixed dc voltages are converted

to ac voltages with IGBT PWM inverters are considered. Since these inverters have the same fixed DC inputs, both are control to produce three-phase ac output voltage with specific amplitude and frequency using an Appropriate PWM generator, which provides gate signals.

The parameters used in the voltage equations of the inverter are as follows:

m- Modulation index

V_{dc} -dc input voltage of the inverter [V]

V_{l-l} -Line-to-line output voltage of the inverter [V] In

PWM inverters, the amplitude of the output ac voltage is a function of the dc input voltage and modulation index. The line-to-line output voltage of such an inverter can be expressed as

$$V_{l-l} = \sqrt{3} \frac{mV_{dc}}{2\sqrt{2}} \tag{6}$$

The inverter output voltage and current are shown in Fig. 6 (a) and (b).from the result, the maximum inverter voltage 400volts and current 80 Amp.

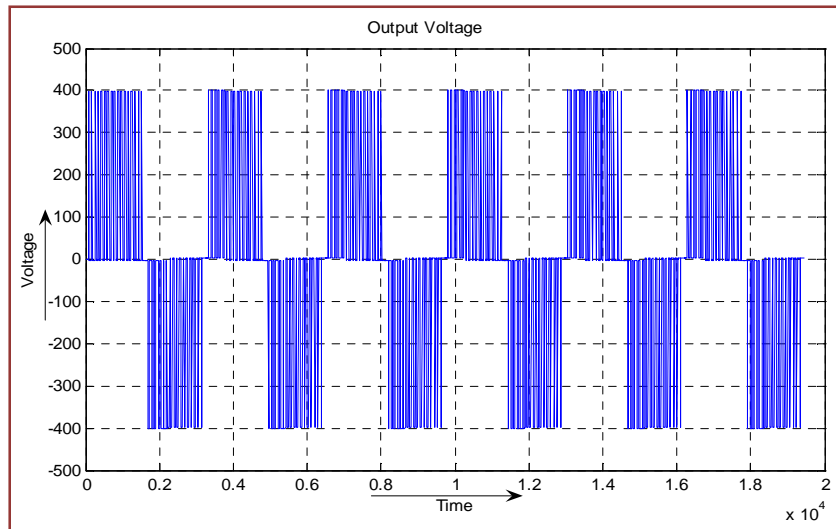

(a) Voltage of Inverter

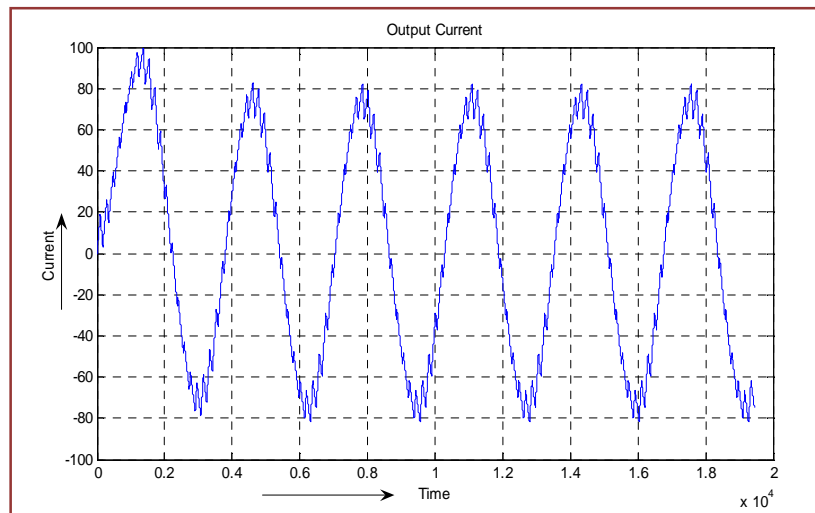

Fig. 6(b). Output current of Inverter

The inverter converts the 24VDC battery voltage to 230VAC 50Hz supply. The output power rating of the inverter is 1000 VA. A battery bank is used as a backup system and it also maintains constant voltage across the load. The battery pack consists of six (6) 12V, 75 Ah batteries connected in series/ parallel configuration, three parallel sets of two batteries in series. This configuration provides 24V, 140Ah. The batteries can be discharged up to 80%.

2.5. Battery Bank

The battery model that we used was capable of modelling the steady state and the dynamic behaviour of the battery. The battery modelled by two circuit diagrams which are coupled via a current controlled current source and a voltage controlled voltage source as shown in the Fig.7.

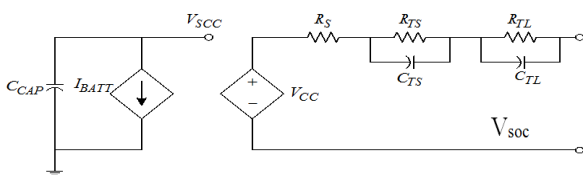

Fig. 7. Equivalent circuit of battery

The state of charge (SOC) of the battery is represented by a large capacitor in the left hand side circuit; the model of the transient behaviour and voltage current relationship of the battery was represented by two RC circuits and series resistance on the right hand side of the diagram.

C_{TL} and R_{TL} are the capacitance and resistance in the long transient RC circuit, C_{TS} and R_{TS} are the capacitance and resistance in the short transient RC circuit, R_S is the series resistance, g is the nonlinear SOC function. The input u is the current entering the battery, and the output y is the voltage across the battery terminals.

All the parameters in the model are multivariable functions of SOC, current, cycle, temperature and number can be calculated by the following equation:

$$C_{CAP} = 3600 * Capacity * f_1(Cycle) * f_1(temp) \quad (7)$$

Where capacity is the nominal capacity in Ahr and $f_1(\text{cycle})$ and $f_2(\text{temp})$ are cycle number and temperature and dependent correction factors, respectively. For this stimulation model, the $f_1(\text{cycle})$ and $f_2(\text{temp})$ are set to one, and the battery capacity is set to 22Ahr.

The open circuit voltage V_{OC} is set to different capacity levels.

$$V_{OC(SOC)} = -1.031e^{-35SOC} + 3.685 + 0.2156SOC - 0.1178SOC^2 + 0.3201SOC^3 \quad (8)$$

All the extracted RC parameters are constants around 20%-100% SOC and vary exponentially surrounded by 0%-20% SOC caused by the electrochemical reaction inside the battery.

3. Load Pattern for Mobile Telephony Base Station

For pre-feasibility study of designing the solar wind hybrid system the 2nd Generation GSM [14] base station is considered. The telecom companies [12] [13] [15] operating in India consider the energy load requirement to be constant for entire year and through out the day of operation. To establish the sanctity of this assumption, the fluke-43B type power quality analyzer is used to measure the power consumption of the base telephony station (BTS). These data gives the actual load demand of particular base station site simulated for the entire year. The assumption of telecom companies are found to be accurate, as there is very low variation in the energy load requirements of a BTS across the day. Here, the power consumption of mobile telephony base station is taken from BSNL (Bharat Sanchar Nigam Limited) India at Vaishali Nagar, Bhopal. The load pattern of base station is shown in Fig.8 (a) and the corresponding voltage and current variation are shown in Fig.8 (b). the average power consumption is 2.53kW, and maximum is 2.73kW and minimum is 2.33 kW. The per day power consumption is 52kWh/d and 2.33 kW peak. The corresponding voltage and current are 560 Volts and 7.4 Amperes peak respectively.

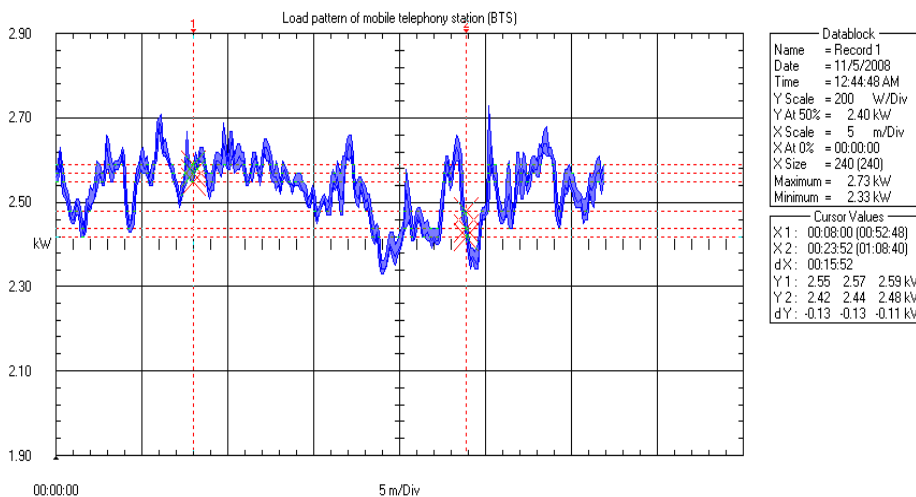

Fig. 8(a). Load Pattern of Mobile Telephony Base Station taken on 11/5/2008

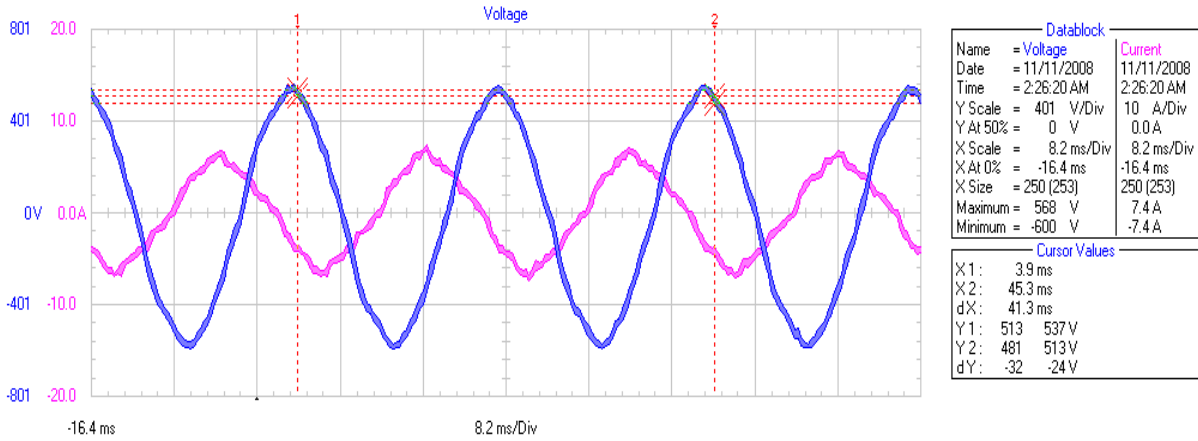

Fig. 8(b). Current and Voltage of Mobile Telephony Base Station taken on 11/11/2008.

4. Study Results for Mobile Telephony Base Station

4.1. Optimization Results

For the analysis of this hybrid system consider three sensitivity variables (wind speed, solar irradiation, fuel cost). For each of the sensitivity values HOMER [11] simulate all the systems in their respective search space. An hourly time series simulation for every possible system type and configuration is done for a 1-year period. An optimal system is defined as a solution for hybrid system configuration that is capable of meeting the load demand of telephony base station.

HOMER eliminates all infeasible combinations and ranks the feasible systems according to increasing net present cost. It also allows a number of parameters to be displayed against the sensitivity variables for identifying an optimal system type. A total of 192 sensitivity cases (product of wind speed

(3), diesel price (2), hub height (2), PV cost multiplier (2), XLR wind turbine cost multiplier (2), battery bank cost multiplier (2), interest rates (2)) were tested with each of the system configurations. Totally 43,200 systems were simulated for 192 cases and nearly million alternatives were examined.

From the study results, the installation of wind solar hybrid system configuration for various locations are most suitable power solutions for telecom base station network in Indian sites. Considering present cost analysis of a PV/Wind hybrid system is suitable for stand-alone loads around Bhopal. For given sensitivity variable the best optimization solution are given in tabular form is shown in Fig.9. From these optimization results the best optimal combination of energy system components are one 7.5kW BWC-Excel-R/48, 5 kW PV-Array and 3.5 kW diesel Generator. Total net present cost (NPC), Capital cost and cost of energy (COE) for such a system is Rs.52,01,382, Rs.12,80,250 and 35Rs./kWh, respectively for one year.

Sensitivity Results		Optimization Results											
Sensitivity variables													
Wind Speed (m/s)	6	Diesel Price (Rs/L)	35										
PV Capital Multiplier	0.85	XLR Capital Multiplier	0.85										
XLR Hub Height (m)	50	Battery Bank Capital Multiplier	0.85										
Interest Rate (%)	6.5												
Double click on a system below for simulation results.													
		<input type="radio"/> Categorized	<input checked="" type="radio"/> Overall										
		<input type="button" value="Export..."/>	<input type="button" value="Details..."/>										
	PV (kW)	XLR (kW)	Gen1 (kW)	Batter... (kW)	Conv. (kW)	Initial Capital (Rs)	Operating Cost (Rs/yr)	Total NPC (Rs)	COE (Rs./kWh)	Ren. Frac.	Capacity Shortage	Diesel (L)	Gen1 (hrs)
	5	1	3.5	16	3.5	1781010	1280250	52,01,382	35.00	0.91	0.00	1,556	1,856
	5	1	3.5	16	5.0	1812345	13,78,258	52,92,245	38.45	0.89	0.00	1,556	1,856
	8	1	3.5	16	3.5	2243565	41,85,324	74,76,165	39.55	0.91	0.00	1,409	1,750
	8	1	3.5	16	5.0	2345454	41,93,567	75,40,213	40.23	0.91	0.00	1,409	1,750
	5	1	3.5	8	3.5	1634579	42,34,456	79,70,940	41.45	0.86	0.00	2,118	2,795
	5	1	3.5	8	5.0	1724574	45,67,789	80,23,345	42.55	0.86	0.00	2,118	2,795
	5	1	5.0	16	3.5	1834575	45,69,345	81,13,324	44.54	0.89	0.00	1,815	1,815
	5	1	5.0	16	5.0	2122333	45,90,456	83,45,567	45.12	0.89	0.00	1,815	1,815
	8	1	3.5	8	3.5	2233333	45,98,765	86,34,452	45.65	0.89	0.00	1,964	2,589
	8	1	3.5	8	5.0	2000345	46,00,456	87,67,693	46.12	0.89	0.00	1,964	2,589
	8	1	5.0	16	3.5	2267010	46,56,789	90,34,567	47.89	0.91	0.00	1,671	1,721
	8	1	5.0	16	5.0	2315610	54,56,783	94,45,567	48.67	0.91	0.00	1,671	1,721
	5	1	5.0	8	3.5	1534743	56,67,345	98,43,226	49.87	0.86	0.00	2,541	2,795
	5	1	5.0	8	5.0	1598764	53,67,876	102,34,333	50.67	0.86	0.00	2,541	2,795
	8	1	5.0	8	3.5	2098233	66,47,645	103,10,670	52.54	0.88	0.00	2,358	2,589
	8	1	5.0	8	5.0	2109333	67,45,678	103,118,236	53.89	0.88	0.00	2,358	2,589

Fig. 9. Optimization results of Wind-Solar-Diesel Generator hybrid energy system.

4.2. Simulation Results

In this simulation results eliminates all infeasible combinations and ranks the feasible systems according to increasing net present cost. It also allows a number of parameters to be display against the sensitivity variables for identifying an optimal system type. The Monthly Average Electricity Production of Hybrid Energy System for mobile telephony base station is shown in Fig.10(b). the best architecture of the system is the combination of 8kW PV, one set of 7.5kW- BWC Excel-R wind turbine generator set, 3.5 kW of generator, a set of battery-bank and 3.5kW Inverter. The simulation results for the best optimal combination of system components are shown in Fig.10(a). The net present cost is Rs.52,01,382, operating cost of the hybrid system is Rs.12,80,250 /yr and cost of energy is about Rs. 35 /kWh. The total production of electrical energy is the combination of energy produced by PV, wind and generator are 46%,41%,13% respectively. The detail Annual electricity production by different hybrid system components is shown in Table 1.

Table 1. Electricity production

Hybrid system resources	kWh/year	Electricity production in %
PV –solar	8,518	46
Wind Turbine	25,465	41
DG set	3, 677	13

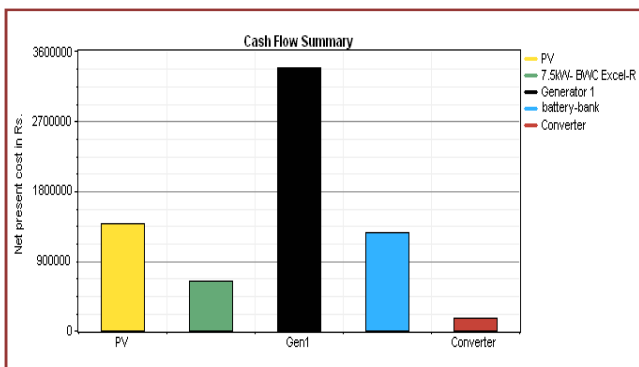

Fig. 10(a). Annual cost of different sources

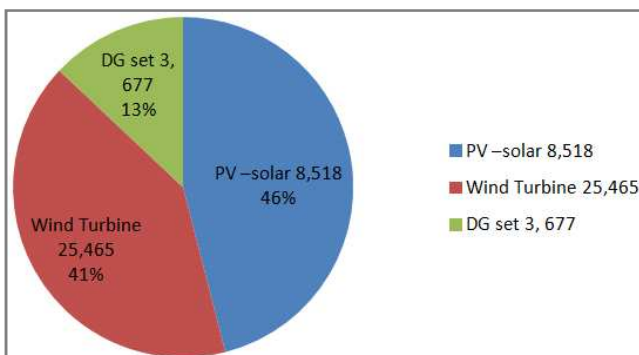

Fig. 10(b). The annual electricity production for the best optimal combination of system components

5. Conclusion

Alternate power solutions are not commonly use in mobile telecommunication system today but are actively evaluated for remote and isolated areas over worldwide. The circumstance of each site was studied in order to decide the feasible combination of alternative energy resources. With the help of above study the solar and wind hybrid energy system are most viable power solution for mobile base station in Indian sites over conventional diesel generator. Although the net present cost is high but the running and maintenance cost are low as compare the diesel generator power solution.

The fuel consumption is also reduces to approximate 80%.with increasing oil prices, payback times on the investment to hybrid solar-wind powered base station sites are continuously decreasing. Considering operating cost and maintenance cost, an autonomous site powered by wind solar hybrid system pay-off after 2-4 years in a good sunny and windy location. The Base stations powered by the solar wind hybrid energy system with diesel backup are proving to be the most environmentally friendly and cost-effective solutions for many challenging sites. Operating and maintenance costs are extremely low, making it economical to extend cellular coverage in far-flung regions. Solar- and wind-powered sites benefit the environment as well due to reduced emission, whether they are located in highly populated or remote areas. Thus powering the base station by hybrid renewable energy systems shall reduce the carbon and other harmful gases (Produce of fuel combustion) emission in environment, by about 90% over the conventional Diesel Generator powered system

In India more than 1.5 billion peoples are mobile user and this number is growing rapidly every day. To provide better network services mobile operators have installed new mobile base stations. Uninterrupted, quality and reliable power with least manual interference is a main concern for remote or isolated base stations, because grid extension is not available or feasible. In these sites the above proposed renewable base hybrid system is the most viable solution. This solution of power supply to the telecom base station is cost effective and available throughout the year.

Acknowledgment

The author gratefully acknowledges the support of the Area Manager, Arera telephone exchange, BSNL-Bhopal for providing telecom base station data used in this study.

References

- [1] M.J.Khan, M.T.Iqbal, "Pre-feasibility study of stand-alone hybrid energy systems for applications in Newfoundland" Science Direct – Renewable Energy-30, 2004, Pg.No-835-854.

- [2] Pragma Nema, Dr. R. K. Nema , Dr. Saroj Rangnekar, “Integrated Design approach for stand alone PV-solar and wind hybrid energy system: For Rural electrifications” ICAER-2007 International conference on advance energy systems, IIT Bombay, India, 2007, pp.354-359
- [3] Pragma Nema, Dr. R.K.Nema, and Dr. Saroj Rangnekar “A current and future state of art development of hybrid energy system using wind and PV-solar: A review,” *Renewable and Sustainable Energy Reviews*, Volume 13, Issue 8, Pages 2096-2103., 2009
- [4] Fernando Valenciaga and Paul F. Puleston “Supervisor Control for a Stand-Alone Hybrid Generation System Using Wind and Photovoltaic Energy,” *IEEE Transactions On Energy Conversion*, Vol.20, NO.2, Pg.No.-398-405, JUNE 2005.
- [5] Nabil A. Ahmed and Masafumi Miyatake “A Stand-Alone Hybrid Generation System Combining Solar Photovoltaic and Wind Turbine with Simple Maximum Power Point Tracking Control,” *IPEMC-IEEE* Pg. No.123-134,2006.
- [6] Ms. Pragma Nema, Dr. R.K.Nema and Dr. Saroj Rangnekar “Sizing and Methodology of PV-Solar/Wind Hybrid Energy Systems,” *National conference of power electronics & intelligent control*, Malaviya National Institute of technology Jaipur (Rajasthan), India, March 17-18, 2007, pp. 291-294.
- [7] Pragma Nema, Dr. R.K. Nema, and Dr. Saroj Rangnekar “Minimisation of Greenhouse Gases Emission by using Hybrid Energy System for Telephony Base Station Site Application,” *Renewable and Sustainable Energy Reviews*, Volume 14, Issue 6, Pages1635-1639, August 2010.
- [8] Pragma Nema, Dr. R.K. Nema and Dr. Saroj Rangnekar “PV Solar/Wind Hybrid Energy System for GSM/CDMA Mobile Telephony Base Station,” *International Journal of Energy and Environment (IJEE)*, Volume 1, Issue 2, Pages 356-362, 2010.
- [9] <http://www.bpsolarindia.com>
- [10] <http://www.bergey.com/>
- [11] <http://www.nrel.gov/internationals/tools/HOMER/homer.htm>
- [12] <http://motorola.com>
- [13] www.ericsson.com
- [14] www.nokiasiemensnetworks.com
- [15] www.vodafone.com
- [16] <http://www.energysolutionscenter.org>
- [17] <http://www.trai.gov.in>